

	ditta	codice	finitura	lato	€
	emuca	89216218921821	grigio	destro	1.90
	emuca	89215218921721	grigio	sinistro	1.90
	emuca	89216218921815	bianco	destro	1.90
	emuca	89215218921715	bianco	sinistro	1.90
	maco	M110415	bianco	destro,sinistro	1.90
	maco	M010415	marrone	destro,sinistro	1.90
	codice	finit.	pz	€	
	B005910	zinc	1	1	
	codice	finitura	misra	€	
	9173305	Zinc.	2metri	5.5	
	codice	h	finitura	€	
	3999517	100		2,65	
	3999017	120		2,80	
	3999417	150		3.80	
 <p>KIT 4 PZ</p>	codice	h	finitura	€	
	C0801205	60		8,90	
	C0801305	100		8,90	
	C0801405	120		8,90	
	c0801505	150		9,80	
 <p>KIT 4 PZ</p>	codice	h	finitura	€	
	C0800905	100		6,70	
	C0801005	120		7,70	
	C0801105	150			
 <p>16 mm.</p>	codice	finitura	h	€	
	19-16		55	0.75	
	codice	finitura	h	€	
	19-16		55	0.60	

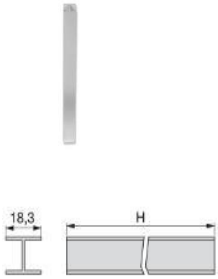

codice	h	finitura	€
8060163	100		7.60
8060263	120		8
8060363	150		8.50



codice	finit.	h	€
8060963	allumi.	150	2.30

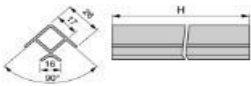

codice	finit.	h	€
8015663	allumi.	150	2.50



codice	finitura	h	€
3913017	plastica		0,25

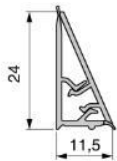

codice	finit.	h	€
8914263	alluminio	24	7.50



codice	finitura	h	€
8914321	Plastica grigia		2.07

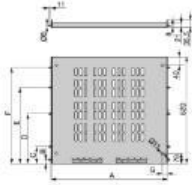

codice	finit.	h	€
8007217	plastica		25.70



codice	finitura	L	€
8062561	alluminio	900	19.40

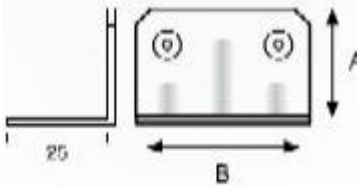

codice			€
			0.15



codice		€
8217405		0,15

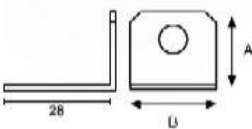

codice	A	B	€
X1722B	22	x 21	0.12

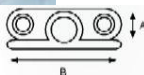

codice	finit.	A	B	€
B021420	zinca. giallo	13	x38	0.75
B021430	bronzato	13	x38	0.75
B021410	ZINCA. CROMO			0.75

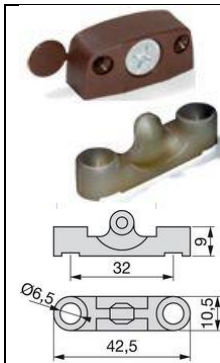

codice	codice		€
50313155231320	bianco		0.55

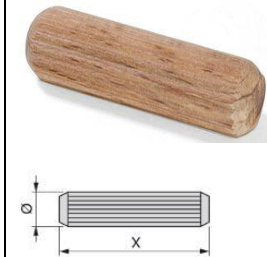

codice	D X	lato	€
9095678	6X30		0.011
9091978	8X30		0.013
9091778	8X40		0,015
9086678	10X30		0,016
9094878	10X40		0,03

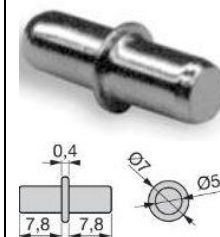

codice	finit.		€
5062305	zincato		0.03



codice	finitura	A B	€
X012115	bianco	13X38	0.11
X012116	noce	13X38	0.11

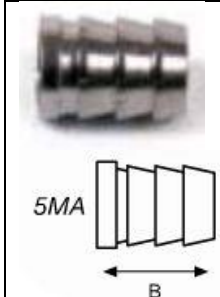

codice	finit.	B	€
B019840	ottone	10	0.11
B019830	bronzato	10	0.11
B019852	nichelato	10	0.11

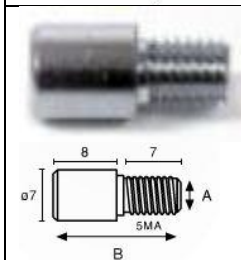

codice	finit.	A B	€
B019740	ottone	A4-15	0.35
B019730	bronzato	A4-15	0.35
B019752	nichelato	A4-15	0.35



codice	finit.	B	€
B019730	ottone	10	
B019752	bronzato	10	
	nichelato	10	

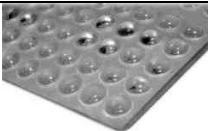

Codice	finitura	A	B	€
3005720	pla.tras.	10	3	0,23
3005920	pla.tras.	7	1,5	0,24
8171020	pla.tras.	10	1,5	0,23



codice	finit.	€
8920521	plas.grigia	0.65

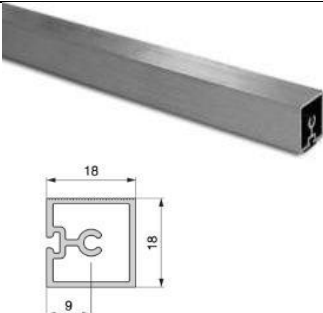

codice	finit.	A	B	€
8920362	alluminio	18X18		5.27

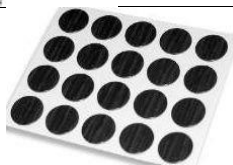

finitura 15 16 17 18 19 21 22 26 30 50 83

codice	diametro	€
51289	13	0.025
51360	20	0.047



codice	ALTEZA	€
G001190	100	3,05
5803602	120	3,50
5803802	150	15